





---

---

---

---

		陈 勇		



.....

.  
.....

.  
.....

.  
.....

.  
.....

.....

.....

/ .....

.....

.....

.....

.....

.....

.....

.....



	●

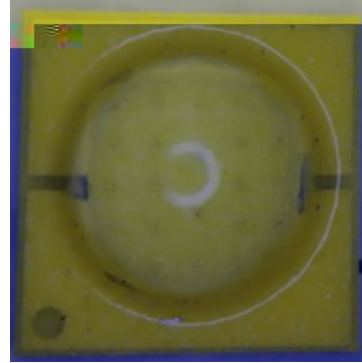

**ATTENTION**  
OBSERVE PRECAUTIONS  
FOR HANDLING  
ELECTROSTATIC  
DISCHARGE  
SENSITIVE  
DEVICES





- 
- 
- 
- 
- 

)便携式照明

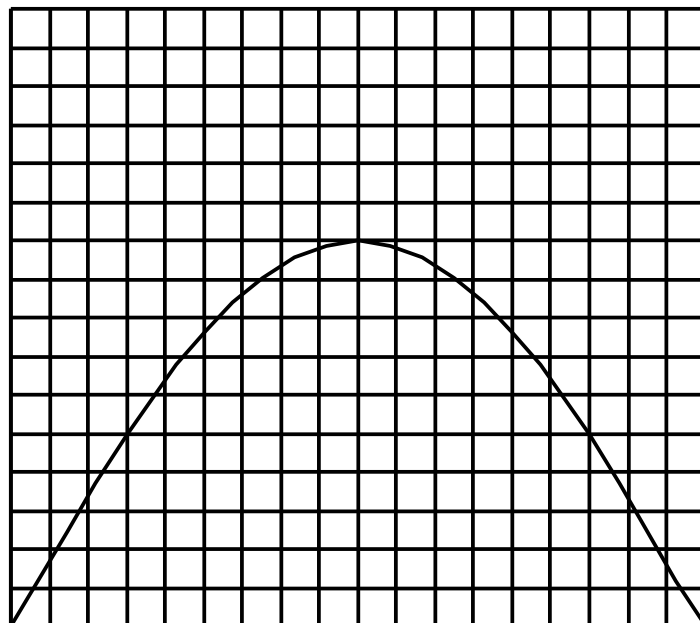
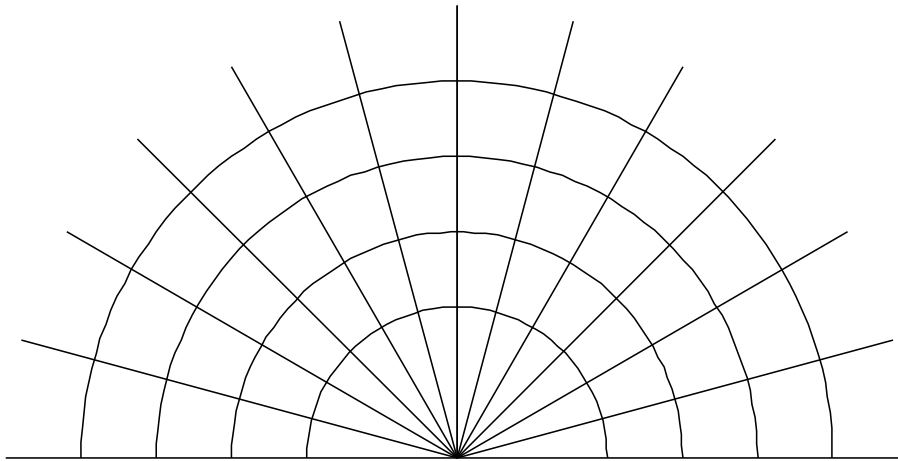



			°
			degrees

°C,





± ± ±

" "

( ) / /

		(	



### 产品分级

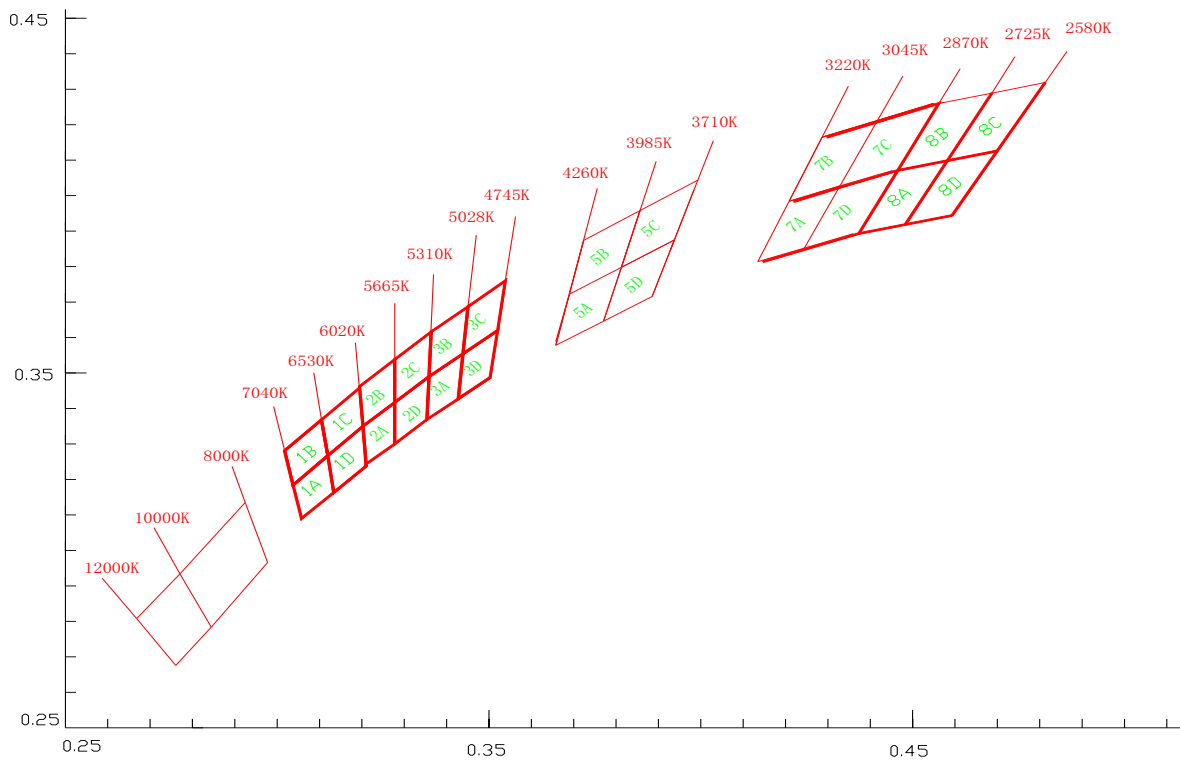

Notes



2.

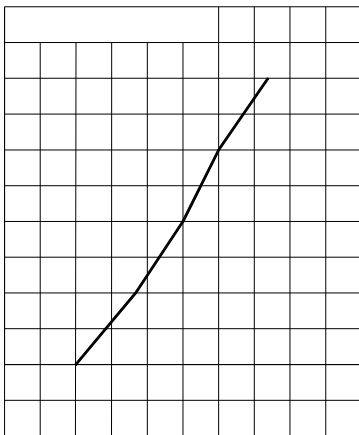
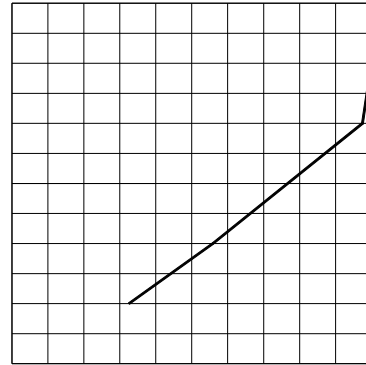
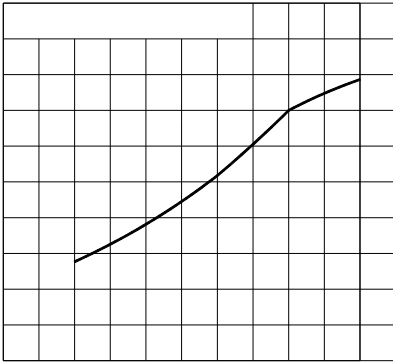

$T_a=25^{\circ}\text{C}$



焊点温度与相对流明曲线图 IF=350mA

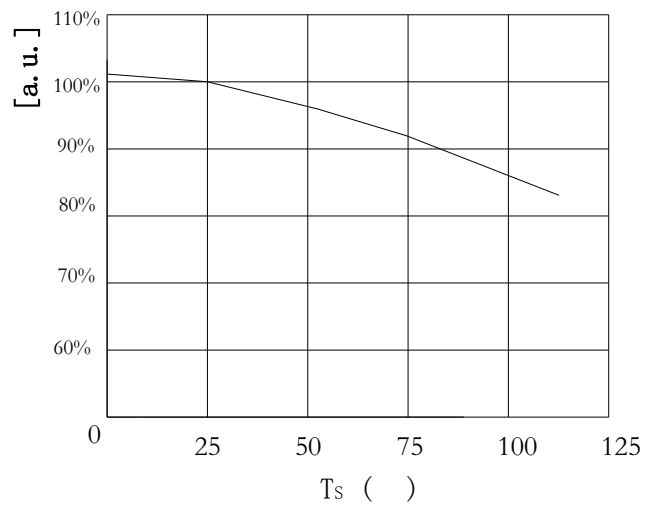





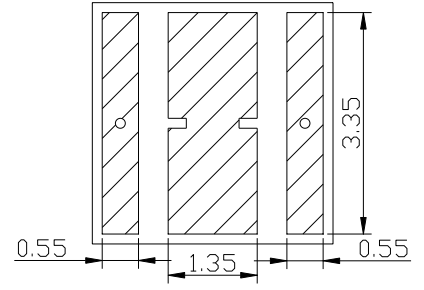
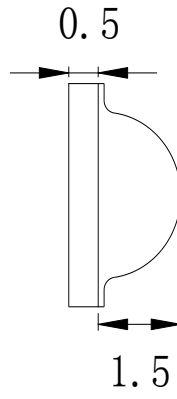
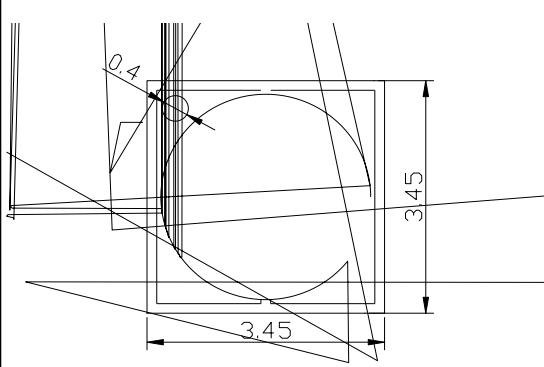

±

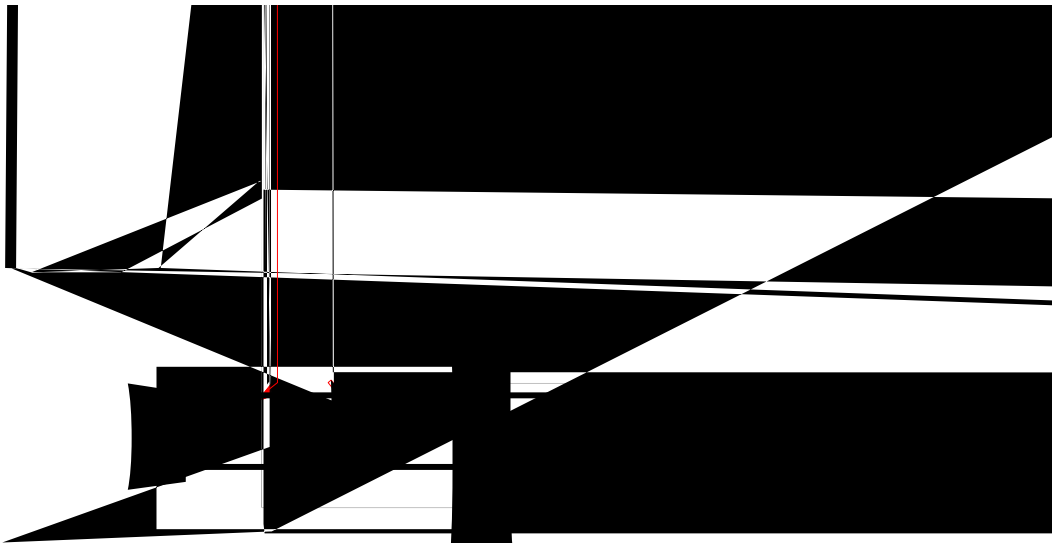





:

Φ

	HONGLITRONIC 鸿利光电	
TYPE:		QTY:
VF:	IF:	ΦV:
TC:	X/Y:	
SDCM<	Ra>	
DATE:	LOT.NO:	

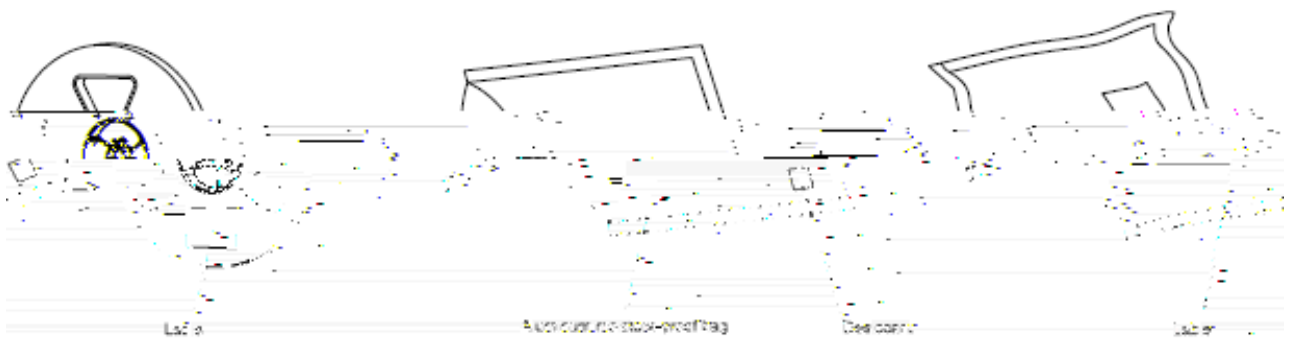
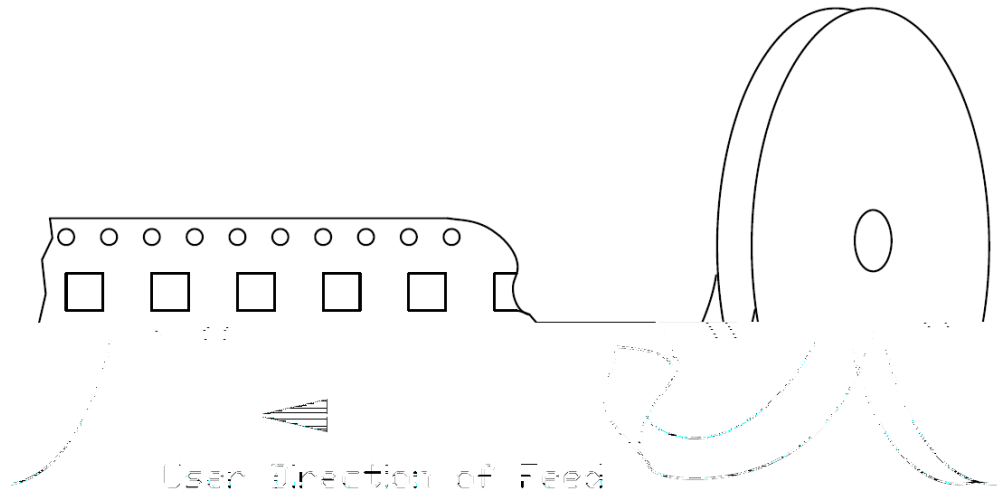
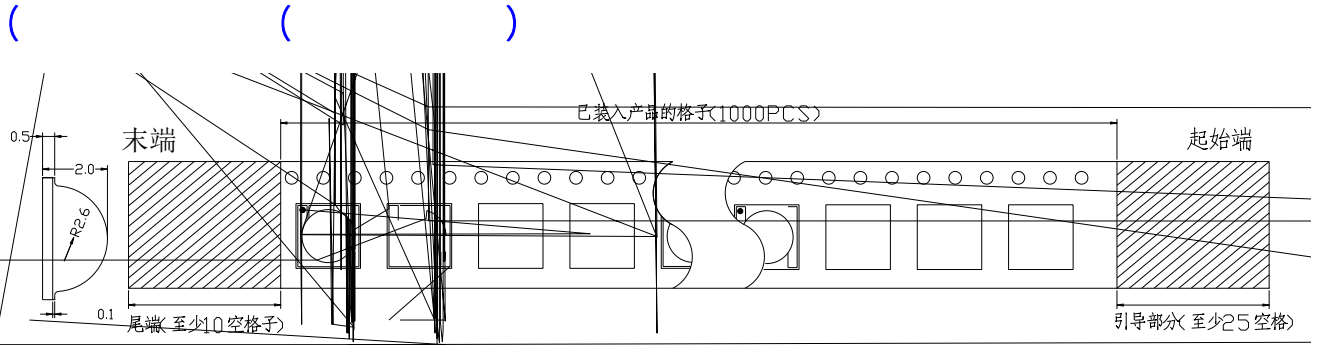



Note:

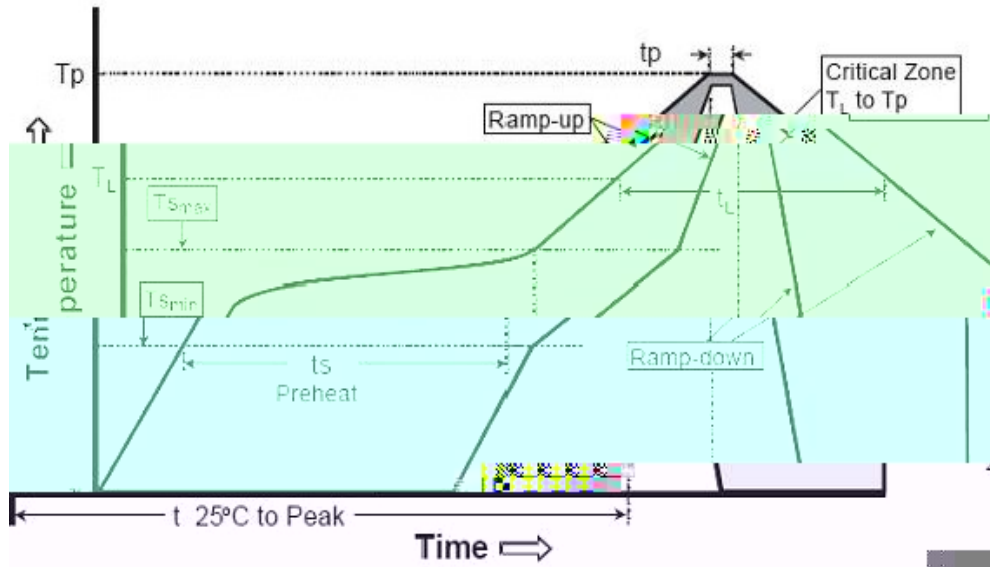

## 使用注意事项

(

(

,



(

(

