



/

-
-
-
-

o

-
-
-
-

o



/

-



/

/

/

/

4

/

/

/

/

= 25 ; l

4

/

/

o

/

/

4

/

/

4

/

4

/ = 25 ; l 4

/ = 25 ; l 4

/ = 25 ; l 4

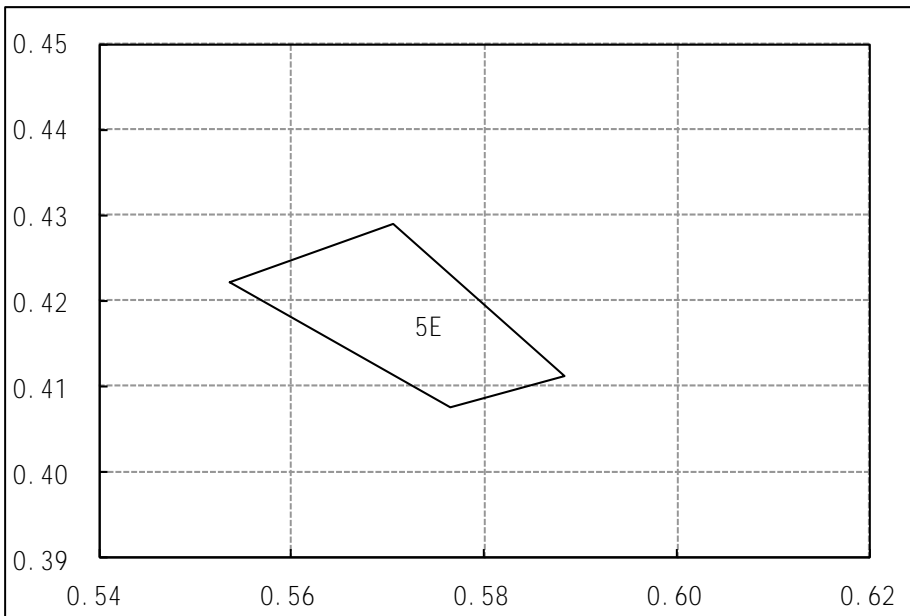

5E	
X	Y
0.5536	0.4221
0.5705	0.4289
0.5764	0.4075
0.5883	0.4111

/
/

4

4

4 = 25 ; l

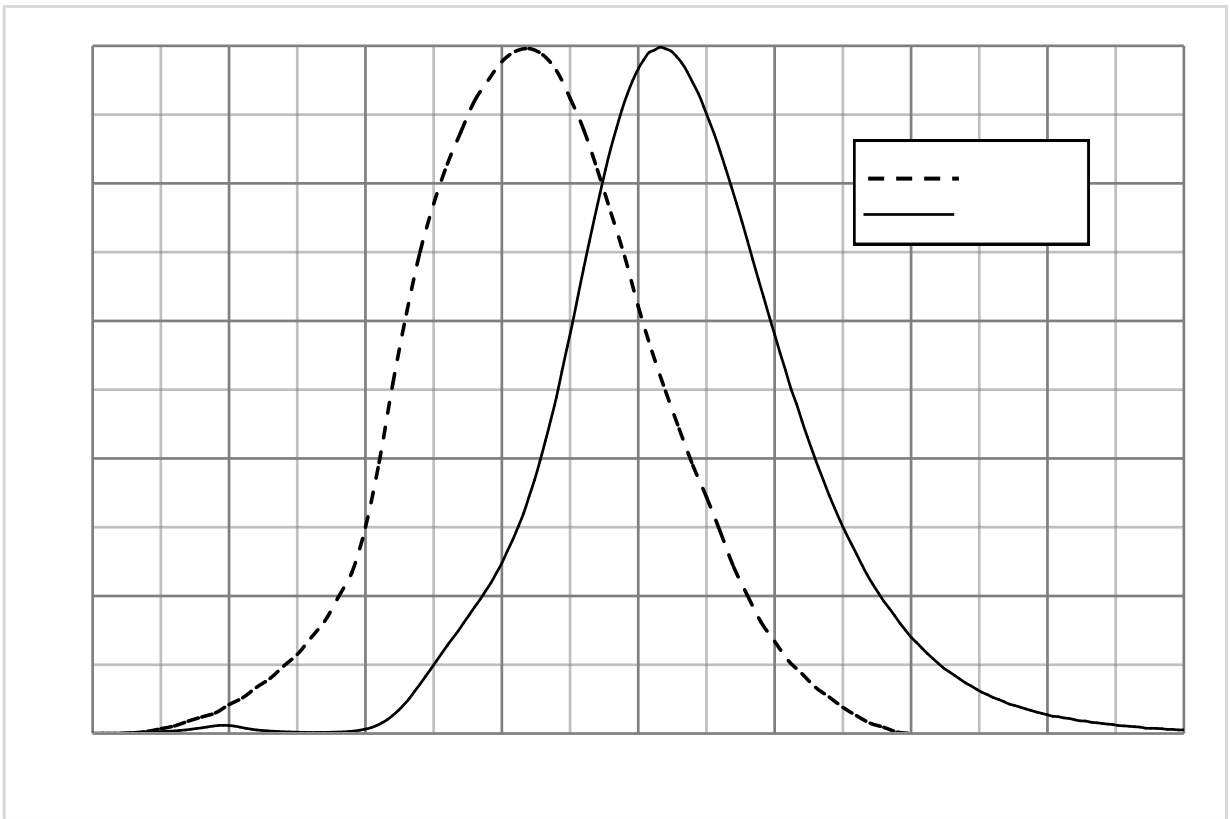

/

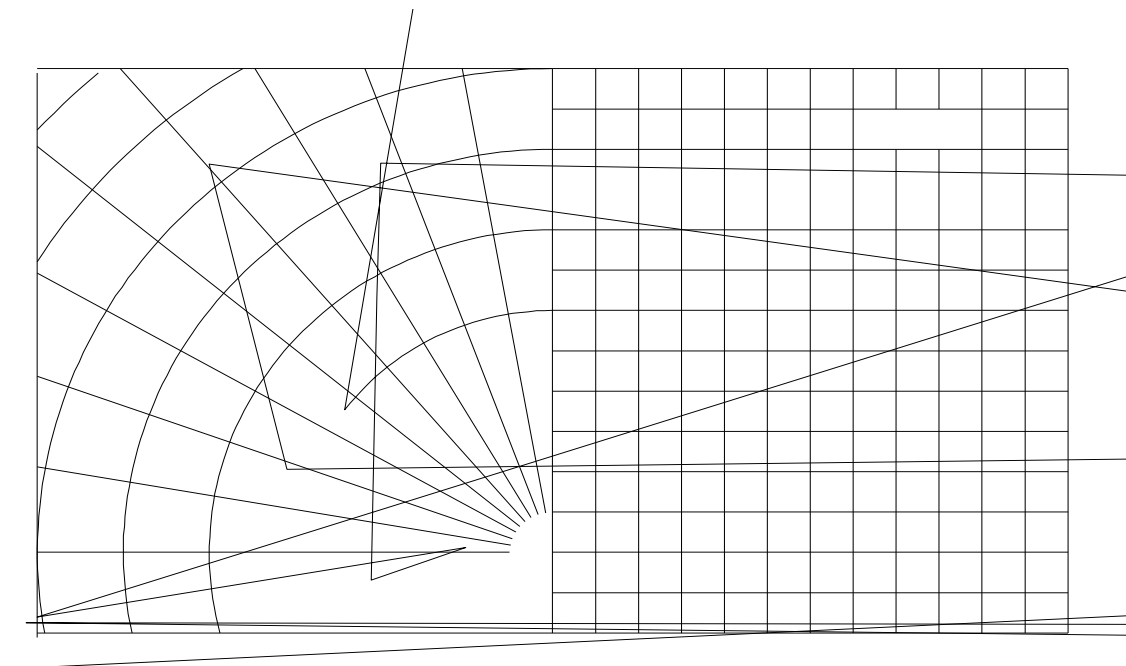

/

$$4 = 25$$

/

$$4 \quad 4 = 25$$

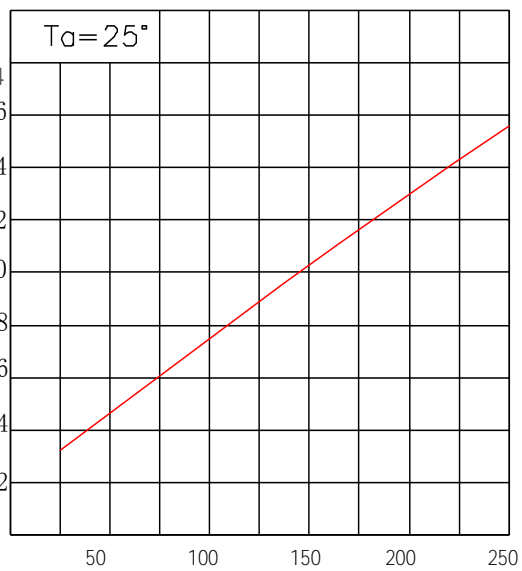
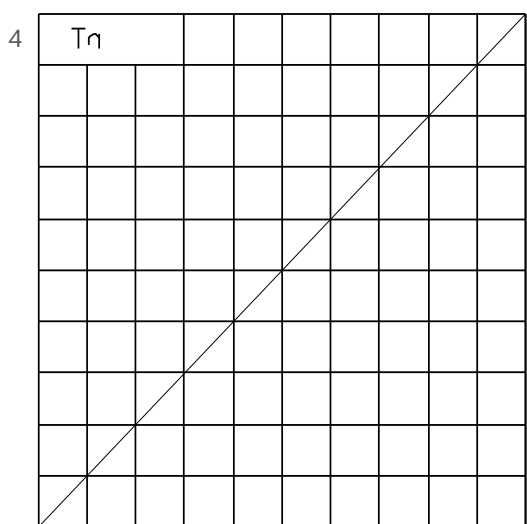

4

4

/
4

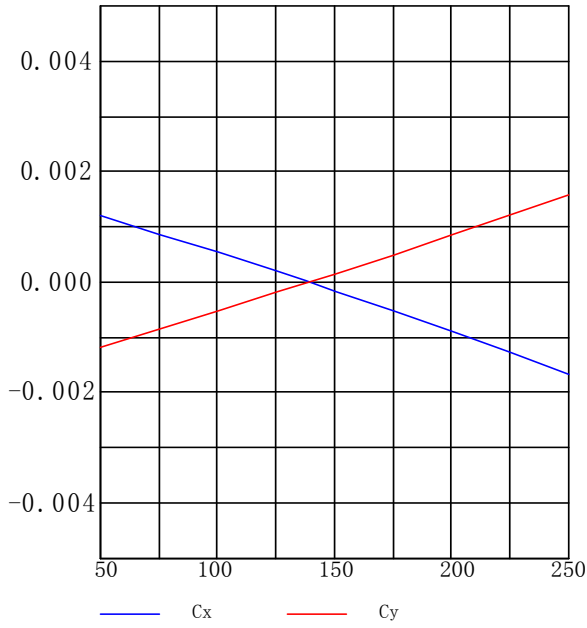

/
(25) = f(T 4

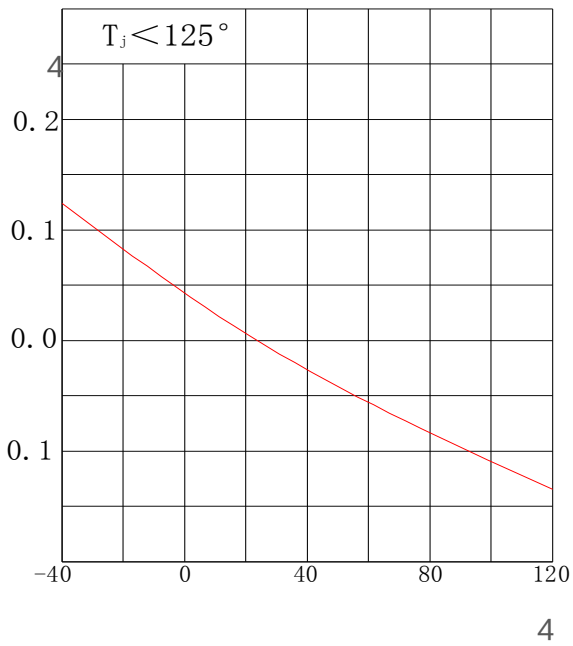

/
(25) = f(T 4

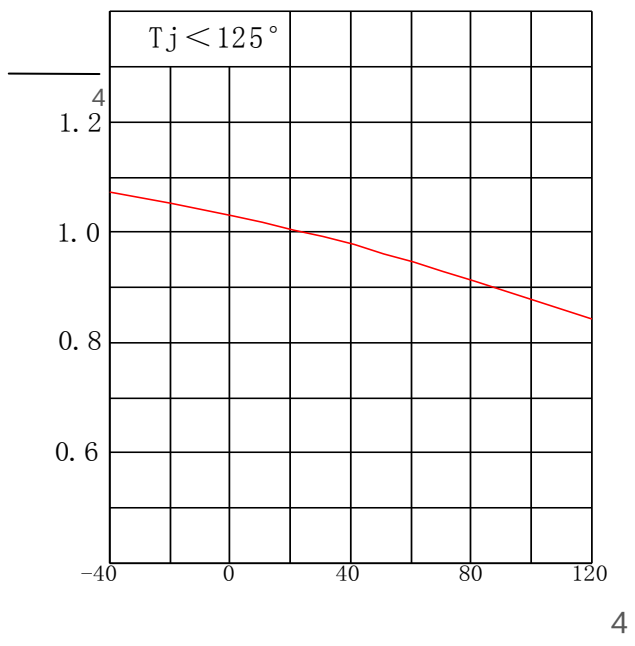

/
4

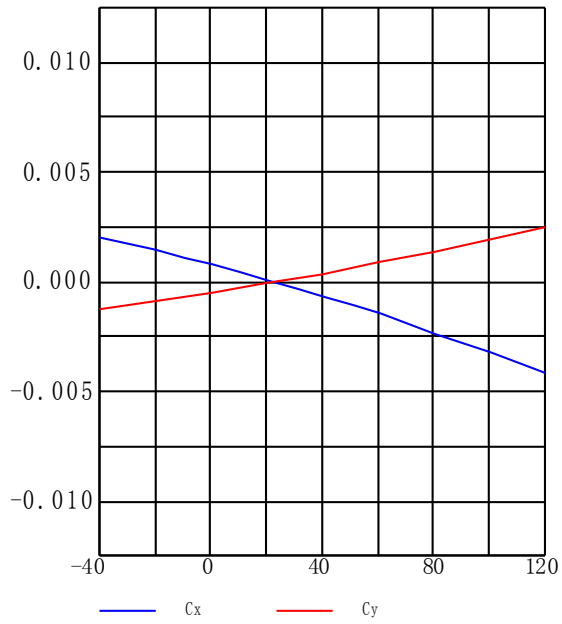

/

4

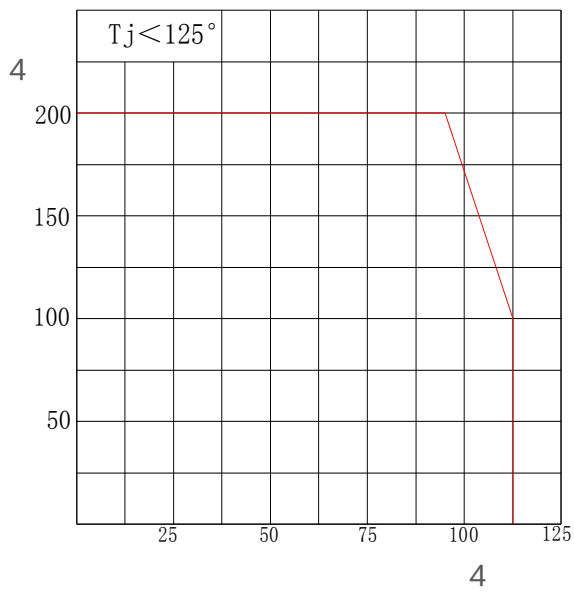

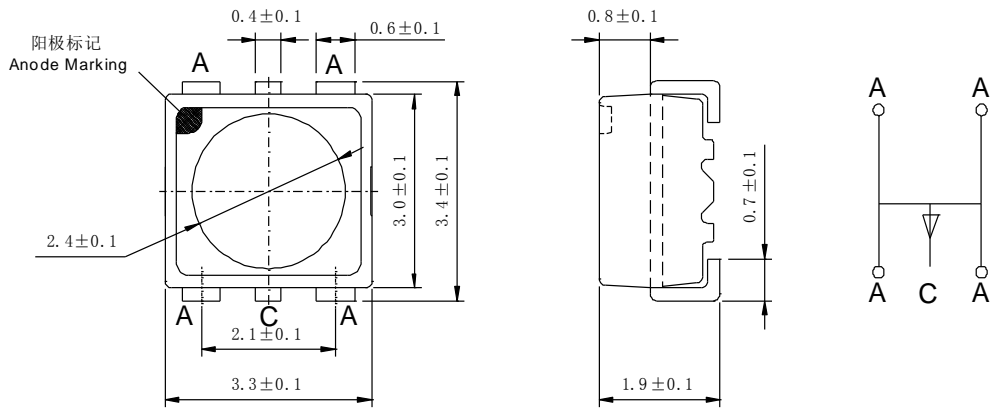

4 40 /90% R.H, 15ppm (4

4 : 25 /75 % R.H, 500

(4 4

4 40 /90% R.H 4

4 mixed gas test: 25 /75 % R.H, 500hours

4

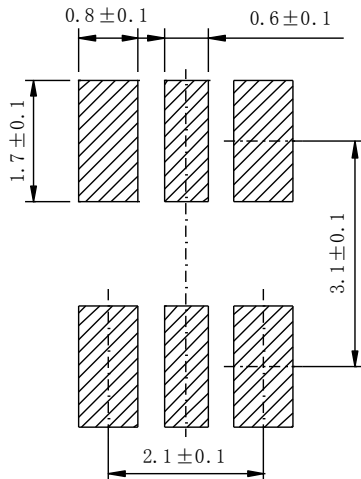

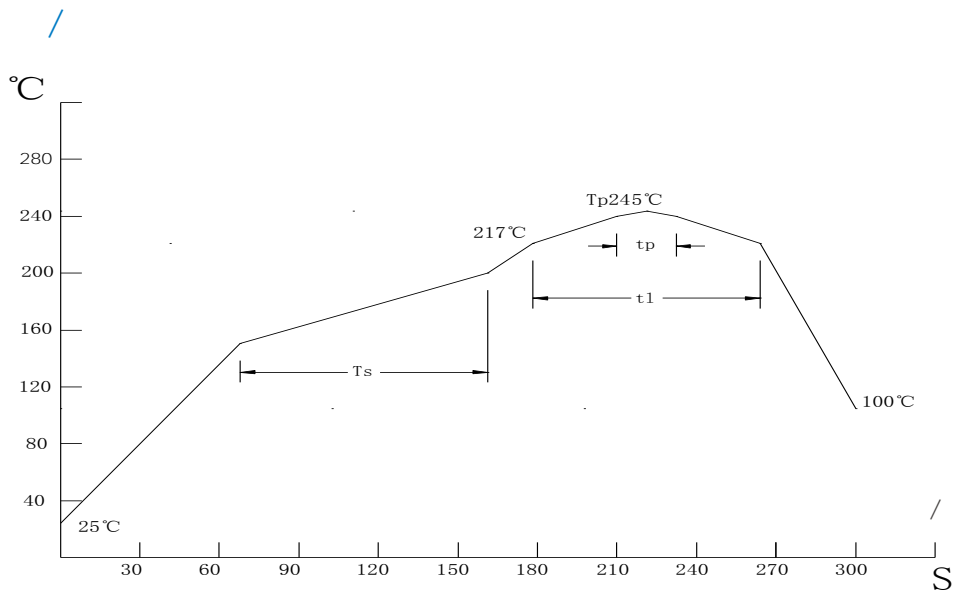

4

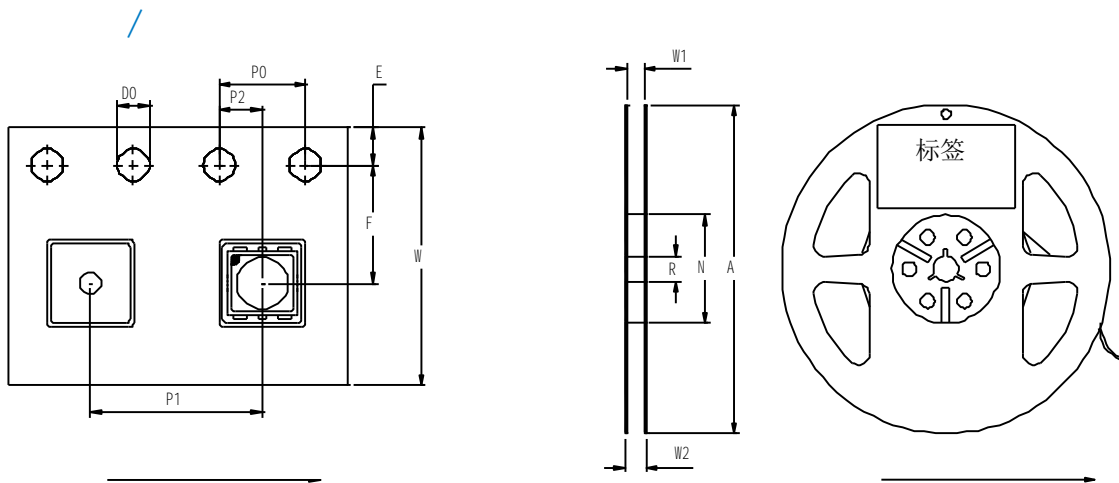

: :

± ± ± ± ± ± ±

± ± ± ±

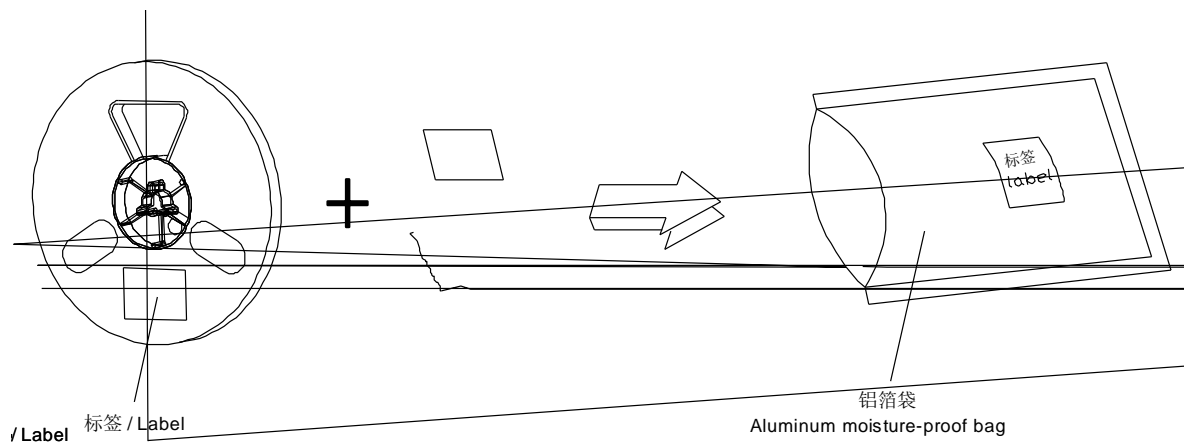

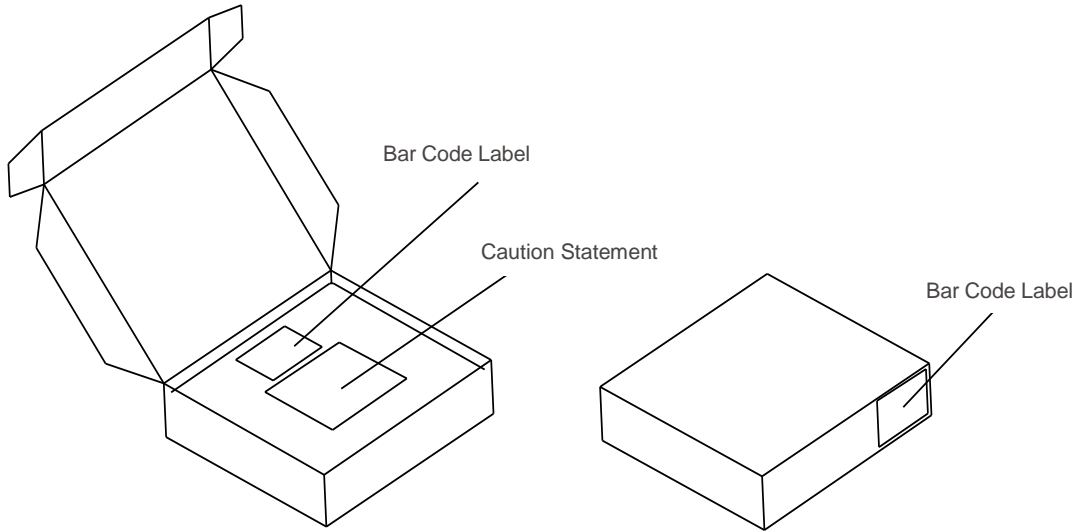

/

4

/

/

/

±

±

±

±

±

±

$\pm 0.1 \text{ mm}$

\pm

\pm

\pm

\pm

\pm

\pm

with an internal reproducibility of $\pm 0.05 \text{ V}$ and an expanded uncertainty of $\pm 0.1 \text{ V}$ (acc. to
4

pulse of typically 25 ms , with an internal reproducibility of ± 0.005 and an expanded uncertainty of ± 0.01 (acc. to GUM with a coverage factor of $k = 3$).

with an internal reproducibility of $\pm 8\%$ and an expanded uncertainty of $\pm 11\%$ (acc. to GUM
4